

ROSES ARE RED
VIOLETS ARE BLUE
CANCER SUCKS

ATP rapidly and reversibly induces Calcium Influx in MCF-7 Breast Cancer Cells

Authors: Nina Raad
Submitted: 18. April 2021
Published: 26. April 2021
Volume: 8
Issue: 2
Affiliation: Universität Freiburg, Germany
Languages: English
Keywords: Cancer, Calcium, Cell, AI, Demetrios
Categories: Medicine, Artificial Intelligence, Modeling and Simulation
DOI: 10.17160/josha.8.2.750

Abstract:

In this experiment by Nina Raad, the MCF-7 breast cancer cell line was used because it is a commonly used breast cancer cell line that has been propagated for many years by multiple groups. It proves to be a suitable model cell line for breast cancer investigations worldwide, including those regarding anticancer drugs. Cells were loaded in the 8 well ship and treated with different concentrations of ATP - (20,30,40,50,70,100 micromolar) . It took from 3 seconds to 120 seconds to obtain the signal, depending on the concentration. The effect was reversible in MCF-7 with lower concentrations of ATP, however, with higher concentrations it was irreversible in some cases due to the toxic effect of ATP on cells; in lower concentrations it takes more time to reach the toxic level.

JOSHA

josha.org

**Journal of Science,
Humanities and Arts**

JOSHA is a service that helps scholars, researchers, and students discover, use, and build upon a wide range of content



Master Thesis

ATP rapidly and reversibly induces calcium influx in MCF-7 breast cancer cells

Author: Nina Raad

Enrolment number: 259765

First examiner: Prof. Dr. hum. biol. Ulrike Salat

Second examiner: Prof. em. Dr. Dr. h.c. mult. Roland Mertelsmann

Submission date: 26.10.2020

I Abstract

Calcium signaling is a simple and cheap test assay, used to investigate whether it is a rapid indicator of apoptosis in response to treatment with ATP or not used as an indicator of apoptosis changes in response to treatment with ATP using machine learning and also to improve cancer therapies using artificial intelligence. Free intracellular calcium is an ubiquitous intracellular second messenger or signal transducer involved in the control of a wide range of cellular functions required for metabolism and survival. A stimulus-induced increase in calcium is necessary for events such as contraction, neurotransmitter and hormone release, cell division, differentiation, and cell death.

In my experiment the MCF-7 breast cancer cell line was used because it is a commonly used breast cancer cell line that has been propagated for many years by multiple groups. It proves to be a suitable model cell line for breast cancer investigations worldwide, including those regarding anticancer drugs.

MCF-7 cells are used ubiquitously in research for ER-positive breast cancer cell experiments, with the majority of the investigations into acquired anti-estrogen drug resistance having utilized them.

MCF-7 cells are well-suited for anti-hormone therapy resistance studies since they are easily cultured and retain ER expression after they have been treated with such targeted-therapy.

To investigate whether the calcium signaling is a rapid indicator of cell death I used Adenosine triphosphate (ATP), which is a ubiquitous extracellular messenger elevated in

the tumor microenvironment. ATP regulates cell functions by acting on purinergic receptors (P2X and P2Y) and activating a series of intracellular signaling pathways.

Upon ligand binding, both receptor subfamilies induce an increase of cytosolic calcium, however, through two distinct mechanisms: the P2X receptors form cation-permeable channels in the plasma membrane leading to the influx of extracellular calcium, while the P2Y proteins activate a signaling cascade resulting in calcium release from the intracellular stores.

Thus, to determine which purinergic receptor subfamily is involved in the ATP-based paracrine signaling we can perform the live calcium imaging experiments in a calcium-free extracellular solution, supplemented with the calcium chelator EGTA.

Activation of P2X receptors, which are nonselective cation channels formed by three homomeric or heteromeric P2X subunits, directly results in Na⁺ and Ca²⁺ influx through the cell plasma membrane, leading to membrane depolarization, which in turn activates voltage-gated Na⁺ and Ca²⁺ channels and causes the firing of action potentials. Activation of P2Y receptors, which are GPCRs, increases cytosolic free Ca²⁺ concentration by inducing Ca²⁺ release from intracellular stores (e.g., sarcoplasmic or endoplasmic reticulum) and Ca²⁺ influx through store-operated (SOC) and/or receptor-operated (ROC) Ca²⁺ channels. P2X and P2Y signaling is not only responsible for inducing action potentials in excitable cells (e.g., neurons), but also has been implicated in cell proliferation, differentiation, and apoptosis.

The LEICA-confocal microscope was then used to get images for Machine learning. The LEICA confocal microscope system which is composed of a regular fluorescence microscope and the confocal part, including scan head, laser optics, computer processing.

It uses fluorescence optics instead of illuminating the whole sample at once, laser light is focused onto a defined spot at a specific depth within the sample. This leads to the emission of fluorescent light at exactly this point. A pinhole inside the optical pathway cuts off signals that are out of focus, thus allowing only the fluorescence signals from the illuminated spot to enter the light detector. Then we used these images for machine learning, which is an application of artificial intelligence (AI) that provides systems the

ability to automatically learn and improve from experience without being explicitly programmed. It focuses on the development of computer programs that can access data and use it to learn for themselves.

Machine learning begins with observations or data, such as examples, direct experience, or instruction, in order to look for patterns in data and make better decisions in the future based on the examples that we provide. The primary aim is to allow the computers to learn automatically without human intervention or assistance and adjust actions accordingly.

Machine learning enables analysis of massive quantities of data. While it generally delivers faster, more accurate results in order to identify profitable opportunities or dangerous risks, it may also require additional time and resources to train it properly. Combining machine learning with AI and cognitive technologies can make it even more effective in processing large volumes of information.

Fluro4-AM was then used. Entering the cells via incubation, Fluo-4 AM ester itself does not bind Ca^{2+} , but it is readily hydrolyzed to Fluo-4 by endogenous esterase once inside cells. Fluo-4 AM ester is often used to measure intracellular calcium in high throughput drug screening.

Fluro-4 is an analog of Fluro-3 with the two chlorine substituents replaced by fluorines, which results in increased fluorescence excitation at 488 nm that gives higher fluorescence signal. Fluo-4 has its absorption maximum at 494 nm, which is essentially nonfluorescent without Ca^{2+} present, but the fluorescence increases at least 100 times on Ca^{2+} binding.

Finally, the cells were loaded in the 8 well ship and treated with different concentrations of ATP - (20,30,40,50,70,100 micromolar) . It took from 3 seconds to 120 seconds to obtain the signal, depending on the concentration.

The effect was reversible in MCF-7 with lower concentrations of ATP, however, with higher concentrations it was irreversible in some cases due to the toxic effect of ATP on cells; in lower concentrations it takes more time to reach the toxic level

II Table of contents

I Abstract

II Table of contents

III List of Abbreviations and Acronyms

Theoretical Background¹

1.1	Calcium	8
1.2	Calcium Signaling	11
1.3	Calcium influx pathways in Human breast cancer cells	14
1.3.1	Mechanism of action.....	17
1.4	Breast Cancer.....	19
1.4.1	spreads of Breast Cancer cells	20
1.4.2	Risk factors for breast cancer	22
1.5	Cancer and MCF-7 Breast cancer cell line	24
1.5.1	MCF-7 Cells	25
1.5.1.1	Characteristics of MCF-7 Cell.....	25
1.6	Fluro 4-AM	26
1.6.1	How Fluro 4-AM affects the cells.....	26
1.7	Microscope used in this thesis	28
1.7.1	Benefits of imaging live cells	28
1.7.2	Live Cell Imaging(Confocal laser microscope).....	29
1.7.3	Microscope Environmental Control.....	30

2 Material and Methods

2.1	Materials	
2.1.2	Adenosine Triphosphate.....	31
2.1.3	DMEM.....	31
2.1.4	Fetal Bovine Serum.....	32
2.1.5	Phosphate Buffered Saline.....	33
2.1.6	Trypsin.....	33
2.1.7	Trypsin Blue.....	34
2.1.8	Pluronic f127.....	34
2.2	Concentration of ATP solution	35
2.3	Used Dyes for measuring cell death.....	35
2.3.1	Fluorescent Dyes	35
2.3.2	Traditional and Novel Calcium Imaging Probes.....	36
2.4	Type of Used chips	38
2.4.1	Application Examples	40
2.4.1.1	Immunofluorescences	40
2.4.2.2	Live Cell Imaging	40

2.5	Cell Culture	41
	2.51 Aseptic Technique.....	42
	2.51 Aseptic Work Area	42
2.6	Thawing Frozen Cells	45
2.7	Significance of Cell Culture	47
3	Results and Discussion	32
3.1	Comparison of different concentrations of ATP.....	49
	3.1.1 Increase the Concentration of ATP to reach the concentration that induce apoptosis	50
3.2	Loweing the Concentration and the amount of ATP	50
3.3	Release of Intracellular Adenosine Triphosphate	54
3.4	Appoptosis and Cell Death	55
4	Discussion	
5	References	

Introduction

1.1 Calcium

A nutrient is most associated with the formation and metabolism of bone. Over 99 percent of total body calcium is found as calcium hydroxyapatite ($\text{Ca}_{10}[\text{PO}_4]_6[\text{OH}]_2$) in bones and teeth, where it provides hard tissue with its strength. Calcium in the circulatory system, extracellular fluid, muscle, and other tissues is critical for mediating vascular contraction and dilation, muscle function, nerve transmission, intracellular signaling, and hormonal secretion.

Bone tissue serves as a reservoir and source of calcium for these critical metabolic needs through the process of bone remodeling. Calcium metabolism is regulated in large part by the parathyroid hormone (PTH)–vitamin D endocrine system, which is characterized by a series of homeostatic feedback loops. The rapid release of mineral from the bone is essential to maintain adequate levels of ionized calcium in serum.

During vitamin D deficiency states, bone metabolism is significantly affected as a result of reduced active calcium absorption. This leads to increased PTH secretion as the calcium sensing receptor in the parathyroid gland senses changes in circulating ionic calcium. Increased PTH levels induce enzyme activity (1α -hydroxylase) in the kidney, which converts vitamin D to its active hormonal form, calcitriol. In turn, calcitriol stimulates enhanced calcium absorption from the gut.

Not surprisingly, the interplay between the dynamics of calcium and vitamin D often complicates the interpretation of data relative to calcium requirements, deficiency states and excess intake.

Calcium is absorbed by active transport (transcellular) and by passive diffusion (paracellularly) across the intestinal mucosa. Active transport of calcium is dependent on the action of calcitriol and the intestinal vitamin D receptor (VDR). This transcellular mechanism is activated by calcitriol and accounts for most of the absorption of calcium

at low and moderate intake levels. Transcellular transport occurs primarily in the duodenum where the VDR is expressed in the highest concentration and is dependent on up-regulation of the responsive genes including the calcium transport protein called transient receptor potential cation channel, vanilloid family member 6 (TRPV6). The up-regulation of VDR and TRPV6 are most obvious during states in which a high efficiency of calcium absorption is required.

Passive diffusion, or paracellular, uptake involves the movement of calcium between mucosal cells and is dependent on luminal serosal electrochemical gradients. Passive diffusion occurs more readily during higher calcium intakes (i.e., when luminal concentrations are high) and can occur throughout the length of the intestine. The permeability of each intestinal segment determines passive diffusion rates. The highest diffusion of calcium occurs in the duodenum, jejunum, and ileum

Calcium is an integral component of the skeleton, and the skeleton provides a reservoir of calcium for other essential calcium-dependent functions throughout the body. The skeleton serves at least three main functions.

First, calcium, as part of the mineral hydroxyapatite, is deposited into the organic matrix of the skeleton. This is critical for bone structure and is necessary for tissue rigidity, strength, and elasticity. This function allows for normal movement and exercise.

Second, the skeleton functions as a source of minerals and alkali and therefore is critical for overall mineral homeostasis.

The skeleton is the principal depot for calcium, containing 98 percent of total body calcium. It can be called on repeatedly, through the processes of bone formation and resorption and to maintain circulating levels of calcium at a constant level. While the same qualitative processes apply to skeletal calcium metabolism across the life cycle, there are quantitative differences by age and hormonal status.

Excessive calcium resorption can compromise the integrity and strength of the skeletal tissues.

Third, the marrow cavity of bone serves as a major site for the development of hematopoietic cells and as a major compartment of the immune system. Several of

the cell types involved in bone remodeling originate in the bone marrow compartment. Stromal or connective tissue cells are found in the bone marrow; at one time, these were thought to be inert, but they are now considered multi-potent stem cells that can become either fat or bone cells under the influence of specific differentiation factors

1.2 Calcium signaling

Calcium signaling is a critical regulator of processes important in cancer, such as apoptosis, proliferation, migration and invasion. A variety of calcium channels and pumps are associated with different cancers. Generally, these associations have been made by the identification of the overexpression of a calcium channel or pump in a cancer, or the identification of a role for a specific calcium channel or pump in a specific cancer-related process

The first realization that they are critical for cellular function is often attributed to Sydney Ringer, who discovered in 1883 that saline solution made up using London tap water (which contained calcium) supported the contraction of isolated frog hearts, whereas saline made up using distilled water (which lacked calcium) could not. Subsequent work revealed that numerous cell biological processes are controlled by calcium. Particularly important was the discovery in the 1950s that calcium triggers skeletal muscle contraction by binding to troponin C and that calcium can be sequestered in the sarcoplasmic reticulum. These studies led to the notion that calcium signals inside cells oscillate: the cytoplasmic calcium concentration increases, a particular effector is activated, and then the calcium signal is reversed to reset the system. Cells use a “toolkit” of channels, pumps, and cytosolic buffers to control calcium levels. Numerous proteins are modulated directly or indirectly by calcium. These include kinases and phosphatases, transcription factors such as NF-AT, and the ubiquitous calcium-binding protein calmodulin (CaM).

Electrical, hormonal, and mechanical stimulation of cells can produce calcium signals by causing entry of the ion across the plasma membrane or its release from intracellular

stores. Binding of hormones to G-protein-coupled receptors (GPCRs), for example, leads to generation of the second messenger inositol 1,4,5-trisphosphate (IP₃), which releases calcium from intracellular stores such as the endoplasmic reticulum. By contrast, electrical or neurotransmitter stimulation of neurons causes calcium to enter cells from outside via channels in the plasma membrane. This can increase the average cytosolic calcium concentration from around 100 nM to around 1 μM. Close to an active channel the calcium concentration can reach tens of micromolar. Such local hot spots of calcium are used by cells to activate specific processes that are generally not sensitive to the bulk cytosolic calcium concentration.

The calcium ions that give rise to a signal Calcium can come from one or two sources: intracellular Ca²⁺ stores and external Ca²⁺ entering across the plasma membrane. Typically, both sources are utilized. The most ubiquitous of the intracellular Ca²⁺ release mechanisms involves the phosphoinositide specific phospholipase C (PI-PLC)-derived second messenger IP₃, which acts by binding to a specific receptor on the endoplasmic reticulum or to a specialized component of the endoplasmic reticulum. The functional IP₃ receptor/channel appears to be a homo tetramer, containing four binding sites for IP₃. Distinct subtypes of the receptor exist, representing products of at least three distinct genes. Additional forms arise as a result of alternative splicing of mRNA the origin of IP₃ and the characteristics of IP₃ receptors.

The other major type of intracellular Ca²⁺ mobilizing receptor is the ryanodine receptor. The ryanodine receptor is named for a toxin that binds to the molecule with high affinity and which led to its purification and characterization. It is also a homo tetramer, with the IP₃ and ryanodine receptors sharing considerable structural homology. In its most specialized setting, skeletal muscle, the ryanodine receptor is gated by a direct conformational interaction with a dihydropyridine receptor in the *t*-tubule membrane. This coupling allows for rapid release of stored Ca²⁺ when an action potential invades the *t*-tubule system

Cellular calcium signaling proteomes are tissue-specific, producing unique calcium signals that suit a tissue's physiology. For example, cardiac myocytes require a rapid (hundreds of milliseconds) whole-cell calcium transient to trigger contraction every second, whereas cells that are not electrically excitable typically display calcium oscillations that last for tens of seconds and can have a periodicity of several minutes, to control gene expression and metabolism. The rapid calcium signals within myocytes are caused by calcium entering through voltage-activated calcium channels in the plasma membrane, which then triggers calcium release via ryanodine receptors on the sarcoplasmic reticulum. Slower calcium signals in non-excitable cells typically rely on IP₃, which binds to channels (InsP₃Rs) on the endoplasmic reticulum, or potentially nicotinic acid adenine dinucleotide phosphate-gated calcium channels (two pore channels) on acidic organelles, leading to release of calcium into the cytoplasm. Calcium signals can also pass through gap junctions to coordinate activities of neighboring cells.

The actions of calcium can be mediated by direct binding of calcium to effectors, such as the phosphatase calcineurin.

Alternatively, it can act via the ubiquitous calcium-binding protein CaM. The interaction of calcium with CaM leads to a rearrangement of the protein that allows it to bind and allosterically regulate target molecules such as the calcium/calmodulin-dependent kinases CaMKII and CaMKIV. CaM is mobile within cells and can associate with its targets after binding calcium. However, in some cases, it is pre-bound to its target, which provides rapid control. Ultimately, calcium signals are reversed by the action of pumps such as the sarco/endoplasmic reticulum ATPases (SERCA) that return it from the cytosol to intracellular stores or the external milieu.

1.3 Calcium influx pathways in Human breast cancer cells

There are a variety of reviews detailing the way in which mammalian cells regulate levels of calcium and the importance of the nature of changes in calcium (such as calcium

oscillations and localized changes in Ca^{2+}) that illustrate some of the main calcium channels, pumps and exchangers involved in calcium signaling pathways. Calcium levels are maintained at low levels through the active efflux of Ca^{2+} from the cell via the plasma membrane Ca^{2+} -ATPases (PMCA), which, along with $\text{Na}^+/\text{Ca}^{2+}$ exchangers and sarco-/endoplasmic reticulum Ca^{2+} ATPases, lower Calcium after activation.

Increases in Calcium can occur by several mechanisms. For example, many GPCRs, through activation of PLC and the generation of inositol 1,4,5-trisphosphate (IP_3), release Ca^{2+} from internal calcium stores, such as the sarco-/endoplasmic reticulum, via IP_3 -activated Ca^{2+} channels. Two other organelles that are involved in Ca^{2+} signaling are mitochondria, which contain the recently identified mitochondrial Ca^{2+} uniporter and $\text{Na}^+/\text{Ca}^{2+}$ exchanger NCLX, and the Golgi, which sequesters intracellular Ca^{2+} via the secretory pathway Ca^{2+} -ATPases (SPCAs). Elevations in Calcium are also achieved through the opening of calcium permeable ion channels on the plasma membrane. Calcium influx plays a critical role in many specific physiological events particularly in excitable cells such as excitation–contraction coupling in skeletal muscle and the release of neurotransmitters in neurons.

Calcium influx through Ca^{2+} permeable ion channels is a key trigger and regulator of a diverse set of cellular events, such as neurotransmitter release and muscle contraction. It is also a regulator of processes relevant to cancer, including cellular proliferation and migration. Cells maintain a large gradient of free Ca^{2+} across the plasma membrane, with intracellular-free Ca^{2+} levels approximately twenty-thousand-fold lower than in the extracellular environment. These cells often exploit this Ca^{2+} gradient to initiate and regulate cellular signals through Ca^{2+} influx, usually via the opening of Ca^{2+} permeable ion channels. Many diverse pathways are regulated by increases in intracellular cytoplasmic-free calcium including muscle contraction, gene transcription, proliferation and neurotransmitter release. Ca^{2+} permeable ion channels are potential pharmacological targets for a variety of conditions.

In the resting state, neurotransmitters are stored in vesicles at the pre-synaptic terminal. Most neurons contain at least two types of synaptic vesicles, small (about 50 nm

diameter) and large (70-200 nm diameter). Neurotransmitters are released in quantal units as each vesicle contains a given amount of transmitter. The vesicles are concentrated near "active zones", dense bodies along the pre-synaptic membrane where neurotransmitter release occurs. At rest, only a small number of vesicles are actually positioned at the active zones. Instead, most are held near the active zones by the proteins synapsin I and actin. Synapsin I, a protein associated with the vesicle membrane, binds to actin, a cytoskeletal filament holding the vesicles in place.

Calcium is a vital element in the process of neurotransmitter release; when Ca^{2+} channels are blocked, neurotransmitter release is inhibited. When the action potential reaches the nerve terminal, voltage dependent Ca^{2+} channels open and Ca^{2+} rushes into the neuron terminal due to a greater extracellular concentration.

Ca^{2+} channels appear to be localized near the active zones of the vesicular membrane. In the giant squid neuron, it has been found that Ca^{2+} influx is ten times greater in the area of the active zone than elsewhere in the neuron. Furthermore, during an action potential, Ca^{2+} concentration at the active zone can rise one-thousand-fold, from 100 nM to 100 micro-M within a few hundred microseconds. The observation of intramembranous proteins thought to be Ca^{2+} channels near active zones is consistent with rapid neurotransmitter release following Ca^{2+} influx.

The resting calcium level in the cytosol is tightly regulated in the range of 100 nanomolar, whereas extracellular Ca^{2+} levels are in the millimolar range. Maintenance of this steep gradient as well as regulation of Ca^{2+} transients that control many cellular processes are derived from two separate ON and OFF mechanisms.

The ON mechanisms that increase calcium depend upon Ca^{2+} entry through channels in the plasma membrane or Ca^{2+} release from intracellular stores in the endoplasmic reticulum (ER) through ryanodine receptors (RYRs) or inositol 1,4,5-trisphosphate receptors (InsP3Rs).

The OFF mechanisms remove Ca^{2+} from the cytosol by use of pumps in the plasma membrane or ER membrane. Other mechanisms for regulating cytosolic Ca^{2+} include cytosolic Ca^{2+} buffers and sequestration of Ca^{2+} in other organelles, such as the mitochondria.

Many chemicals and drugs are capable of affecting these ON and OFF mechanisms because each cell type has its own sensory mechanisms that can generate Ca^{2+} signals suitable to its physiology.

In other words the ON mechanisms involve the use of channels in the plasma membrane (voltage operated channels (VOC) , receptor operated channels (ROC), store operated channels (SOC) to allow entry of Ca^{2+} release through ryanodine receptors or inositol triphosphate receptors.

The OFF mechanisms remove Ca^{2+} from the cytoplasm using cytosolic buffers and pumps such as the membrane Na^+/Ca^+ exchanger and the plasma membrane Ca^{2+} ATPase. PMCA is regulated by a variety of factors including calmodulin, acidic phospholipids, and protein kinases A and C.

Mitochondria also plays an important role in accumulating Ca^{2+} up to a level beyond which permeability transition pore develops that can lead to depolarization, release of cytochrome c and therefore apoptosis.

1.3.1 Calcium influx pathways in human cells

There are many types of calcium permeable ion channels expressed in intracellular organelles, such as the isoforms of IP_3 receptors ($\text{IP}_3\text{R1}$, $\text{IP}_3\text{R2}$ and $\text{IP}_3\text{R3}$) and the mediators of calcium-induced calcium release known as ryanodine receptors (RyR1 , RyR2 and RyR3) , there are many more calcium permeable ion channels that are expressed on the plasma membrane of human cells.

The figure shown represents examples of some of the key Ca^{2+} influx pathways and examples of their naturally occurring activators.

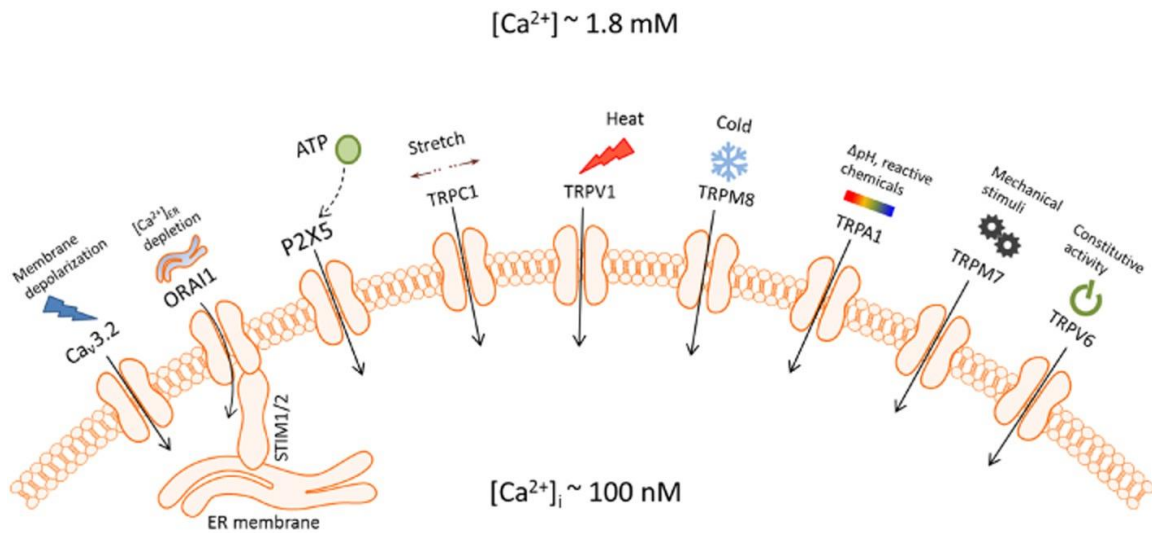

Cav3.2 is an example of a voltage gated Ca^{2+} channel that is activated by membrane depolarization

ORAI1 is an example of a store operated Ca^{2+} channel that is activated upon depletion of endoplasmic reticulum Ca^{2+} stores

P2X5 is an example of a purine receptor that facilitates the flow of Ca^{2+} across the plasma membrane in response to extracellular ATP

examples of TRP channels include the canonical mechanosensitive cation channel TRPC1, which can be activated by membrane stretch

The vanilloid TRPV1 channels activated by high temperatures

The melastatin TRPM8 channel activated by lower temperatures

The sole member of ankyrin TRPA family TRPA1, which is a key chemoreceptor responsive to reactive chemicals

TRPM7, which can be directly activated by mechanical stress

TRPV6, which has constitutive activity at low Calcium and physiological membrane potential

1.4 breast cancer

Breast cancer is the most frequent malignancy in females. Due to its major impact on population, this disease represents a critical public health problem that requires further research at the molecular level in order to define its prognosis and specific treatment.

It is the most frequently diagnosed cancer and the leading cause of cancer death among females, accounting for 23% of the total cancer cases and 14% of the cancer deaths; thus, research in this field is important to overcome both economical and psychological burden.

In recent years it has become clear that breast cancer does not represent a single disease but rather a number of molecularly distinct tumors arising from the epithelial cells of the breast.

Breast cancer arises in the milk-producing glands of the breast tissue. Groups of glands in normal breast tissue are called lobules. The products of these glands are secreted into a duct system that leads to the nipple. Depending on where, in the glandular or ductal unit of the breast, the cancer arises, it will develop certain characteristics that are used to sub-classify breast cancer into types

Breast cancer develops due to DNA damage and genetic mutations that can be influenced by exposure to estrogen. Sometimes there will be an inheritance of DNA defects or pro-cancerous genes like BRCA1 and BRCA2. Thus, the family history of breast cancer increases the risk for breast cancer development. In the normal individual, the immune system attacks cells with abnormal DNA or abnormal growth. This fails in those with breast cancer disease leading to the tumor growth and spread.

Most early breast cancer patients are asymptomatic and discovered during screening mammography. With increasing size, the patient may discover cancer as a lump that is felt accidentally mostly during combing or showering. Breast pain is an unusual symptom that happens 5% of the time.

The locally advanced disease may be presented with peau d'orange, frank ulceration, or fixation to the chest wall. Inflammatory breast cancer, an advanced form of breast cancer frequently resembles breast abscess and presents with swelling, redness, and other local signs of inflammation. Paget disease of the nipple usually presents with nipple changes that must be differentiated from nipple eczema.

1.41 Spreads of Breast Cancer Cells

The primary tumor begins in the breast itself, but once it becomes invasive, it may progress beyond the breast to the regional lymph nodes or travel (metastasize) to other organ systems in the body and become systemic in nature.

Lymph is the clear, protein-rich fluid that bathes the cells throughout the body. Lymph will work its way back to the bloodstream via small channels known as lymphatics.

Along the way, the lymph is filtered through cellular stations known as nodes, thus they are called lymph nodes.

Nearly all organs in the body have a primary lymph node group filtering fluid that comes from that organ. In the breast, the primary lymph nodes are under the armpit, or axilla. Classically, the primary tumor begins in the breast and the first place to which it is likely to spread is the regional lymph nodes.

Cancer begins when healthy cells change and grow out of control, forming a mass or sheet of cells called a tumor. A tumor can be cancerous or benign. A cancerous tumor is malignant, meaning it can grow and spread to other parts of the body.

A benign tumor means the tumor can grow but will not spread. When breast cancer is limited to the breast and/or nearby lymph node regions, it is called

early stage or locally advanced. When breast cancer spreads to an area farther from where it started, doctors say that the cancer has “metastasized.” They call the area of spread a “metastasis,” or “metastases” if the cancer has spread to more than one area. The disease is called metastatic breast cancer. Another name for metastatic breast cancer is “stage IV (4) breast cancer.”

Doctors assign the stage of the cancer by combining the different classifications, the tumor grade, and the results of ER/PR and HER2 testing. This information is used to help determine the prognosis.

Most patients are anxious to learn the exact stage of the cancer. If they have surgery as the first treatment for cancer, Doctor will generally confirm the stage of the cancer when the testing after surgery is finalized, usually about 5 to 7 days after surgery. When systemic treatment is given before surgery, which is typically with medications and is called neoadjuvant therapy, the stage of the cancer is primarily determined clinically. Doctors may refer to stage I to stage IIA cancer as "early stage" and stage IIB to stage III as "locally advanced."

Stage 0: Stage zero (0) describes disease that is only in the ducts of the breast tissue and has not spread to the surrounding tissue of the breast. It is also called non-invasive.

Stage IA: The tumor is small, invasive, and has not spread to the lymph nodes.

Stage IB: Cancer has spread to the lymph nodes and the cancer in the lymph node is larger than 0.2 mm but less than 2 mm in size. There is either no evidence of a tumor in the breast or the tumor in the breast is 20 mm or smaller.

Stage IIA: Any 1 of these conditions:

- There is no evidence of a tumor in the breast, but the cancer has spread to 1 to 3 axillary lymph nodes. It has not spread to distant parts of the body.
- The tumor is 20 mm or smaller and has spread to 1 to 3 axillary lymph nodes.

- The tumor is larger than 20 mm but not larger than 50 mm and has not spread to the axillary lymph nodes.

Stage IIB: Either of these conditions:

- The tumor is larger than 20 mm but not larger than 50 mm and has spread to 1 to 3 axillary lymph nodes.
- The tumor is larger than 50 mm but has not spread to the axillary lymph nodes.

Stage IIIA: The cancer of any size has spread to 4 to 9 axillary lymph nodes or to internal mammary lymph nodes. It has not spread to other parts of the body. Stage IIIA may also be a tumor larger than 50 mm that has spread to 1 to 3 axillary lymph nodes.

Stage IIIB: The tumor has spread to the chest wall or caused swelling or ulceration of the breast, or it is diagnosed as inflammatory breast cancer. It may or may not have spread to up to 9 axillary or internal mammary lymph nodes.

Stage IIIC: A tumor of any size that has spread to 10 or more axillary lymph nodes, the internal mammary lymph nodes, and/or the lymph nodes under the collarbone. It has not spread to other parts of the body.

Stage IV (metastatic): The tumor can be any size and has spread to other organs, such as the bones, lungs, brain, liver, distant lymph nodes, or chest wall.

Metastatic cancer found when the cancer is first diagnosed occurs about 6% of the time. This may be called de novo metastatic breast cancer. Most commonly, metastatic breast cancer is found after a previous diagnosis of early breast cancer. Learn more about metastatic breast cancer.

1.42 Risk factors for breast cancer can be divided into 7 broad categories:

1. Age: The age-adjusted incidence of breast cancer continues to increase with advancing age of the female population.
2. Gender: Most breast cancers occur in women.

3. Personal history of breast cancer: A history of cancer in one breast increases the likelihood of a second primary cancer in the contralateral breast.
4. Histologic risk factors: Histologic abnormalities diagnosed by breast biopsy constitute an important category of breast cancer risk factors. These abnormalities include lobular carcinoma in situ (LCIS) and proliferative changes with atypia.
5. The family history of breast cancer and genetic risk factors: First-degree relatives of patients with breast cancer have a 2-fold to 3-fold excess risk for development of the disease. Five percent to 10% of all breast cancer cases are due to genetic factors, but they may account for 25% of cases in women younger than 30 years. BRCA1 and BRCA2 are the 2 most important genes responsible for increased breast cancer susceptibility.
6. Reproductive risk factors: Reproductive milestones that increase a woman's lifetime estrogen exposure are thought to increase her breast cancer risk. These include the onset of menarche before 12 years of age, first live childbirth after age 30 years, nulliparity, and menopause after age 55 years.
7. Exogenous hormone use: Therapeutic or supplemental estrogen and progesterone are taken for various conditions, with the two most common scenarios being contraception in premenopausal women and hormone replacement therapy in postmenopausal women.

Breast cancer develops due to DNA damage and genetic mutations that can be influenced by exposure to estrogen. Sometimes there will be an inheritance of DNA defects or pro-cancerous genes like BRCA1 and BRCA2.

Thus, the family history of ovarian or breast cancer increases the risk for breast cancer development. In the normal individual, the immune system attacks cells with abnormal DNA or abnormal growth. This fails in those with breast cancer disease leading to the tumor growth and spread.

1.5 Cancer and MCF-7 Breast cancer cell line

In order to define breast cancer prognosis and self-treatment, basic research is required to accomplish this task, and this involves cell lines as they can be widely used in many aspects of laboratory research and, particularly, as in vitro models in cancer research. MCF-7 is a commonly used breast cancer cell line that has been promoted for more than 40 years by multiple research groups.

It is ER-positive and progesterone receptor (PR)-positive and belongs to the luminal A molecular subtype. MCF-7 is a poorly aggressive and non-invasive cell line. normally being considered to have low metastatic potential.

MCF-7 cells are used ubiquitously in research for ER-positive breast cancer cell experiments, with the majority of the investigations into acquired anti-estrogen drug resistance having utilized them.

MCF-7 cells are well-suited for anti-hormone therapy resistance studies since they are easily cultured and retain ER expression when they are treated with such targeted-therapy.

This cell line seems to be a key element for the molecular diagnosis in breast cancer as they can be widely used in many aspects of laboratory research and, particularly, as in vitro models in cancer research.

As for breast cancer, MCF-7 cells represent a very important candidate as they are used ubiquitously in research for estrogen receptor (ER)-positive breast cancer cell experiments. Many sub-clones, which have been established, represent different classes of ER-positive tumors with varying nuclear receptor expression levels.

1.51 MCF-7 cell line

Human Caucasian breast adenocarcinoma established from the pleural effusion from a 69 year female Caucasian suffering from a breast adenocarcinoma. Cells exhibit some features of differentiated mammary epithelium including estradiol synthesis and formation of domes. Cells may carry B or C type retrovirus and are considered to represent a category 2 pathogen (P2 containment). Cells express both the wild type and variant estrogen receptors as well as progesterone receptors.

1.52 Characteristics of MCF-7 Cell line

MCF-7 cells are used ubiquitously in research for ER-positive breast cancer cell experiments, with the majority of the investigations into acquired anti-estrogen drug resistance having utilized them. MCF-7 cells are well-suited for anti-hormone therapy resistance studies since they are easily cultured and retain ER expression when they are treated with such targeted-therapy. To investigate the properties of acquired antihormone-resistant breast cancer cells, populations of MCF-7 cells, adapted to various anti-hormone environments, have been created.

The growth of breast cancer cells is controlled not only by ER and PR but also by plasma membrane-associated growth factor receptors. Two particularly important members of this large family are the epidermal growth factor receptor (EGFR), which is activated by the epidermal growth factor (EGF), and the human epidermal growth factor receptor-2 (HER2), both present in MCF-7 cells

1.6 Fluo-4 AM

Fluo-4 AM ester can be used to detect intracellular free calcium by fluorescence microscopy, flow cytometry, or fluorescence microplate reader Membrane-permeant AM ester form of Fluo-4 that can enter into cells via incubation. Fluo-4 AM ester itself does not bind Ca^{2+} , but it is readily hydrolyzed to Fluo-4 by endogenous esterases once inside cells. Fluo-4 AM ester is often used to measure intracellular calcium in high throughput drug screening.

Fluo-4 has its absorption maximum at 494 nm, thus making it excitable by the argon-ion laser. Fluo-4 is essentially nonfluorescent without Ca^{2+} present, but the fluorescence increases at least 100 times on Ca^{2+} binding. Also, because Fluo-4 binds Ca^{2+} more weakly

(higher K_d) than do fura-2 and indo-1, it is more useful for measuring high transient Ca^{2+} concentration during Ca^{2+} spikes.

1.61 Fluorescent Dyes

Calcium indicators are unable to cross lipid membranes due to their nature, making necessary the use of physical or chemical methods to load them inside the cell.

Loading Acetoxymethyl (AM) esters: the protection of carboxylic groups as AM esters makes the dye neutral, so it can cross the cell membrane. Once inside the cell, esterases will cleave AM groups. This process gives place to charged compounds that are entrapped inside the cell.

Ca^{2+} indicators bind and interact only with freely diffusible Ca^{2+} ions. In this light, it is important to remember that the majority of Ca^{2+} within cells is not free to diffuse but tightly bound to various cellular buffers. The ratio of bound to free Ca^{2+} varies from cell to cell as well as within the various compartments of the cell. In very general terms, cytosolic Ca^{2+} is buffered 100 to 1, meaning that for every 100 Ca^{2+} ions in the cytosol, only 1 ion is free to diffuse. The bound to free ratio of Ca^{2+} within the endoplasmic reticulum is of the order of 10 to 1. Chemical Ca^{2+} indicators themselves also act as Ca^{2+} buffers and can therefore impact both the levels and most noticeably, the kinetics of Ca^{2+} signaling within cells. It is for these reasons that users must carefully consider not only the spectral characteristics of a chemical indicator, but it is also important to pay close attention to its binding properties.

Ca^{2+} indicator dyes were engineered with AM esters to offer a more convenient method for loading hydrophilic dyes into cells. AM dyes are sufficiently hydrophobic that they are membrane permeable and can be passively loaded into cells simply by adding them to the extracellular medium.

Intracellular esterases then cleave the AM group and trap the dye inside cells. This method of dye loading also effectively concentrates Ca^{2+} indicators inside cells such that

a bath concentration of 1-5 μM results in a cytosolic concentration of greater than 100 μM . Another advantage of using AM-linked Ca^{2+} dyes is that subcellular compartments can be labeled. For example, low affinity Ca^{2+} indicators can be used to monitor Ca^{2+} levels in the endoplasmic reticulum.

Ca^{2+} indicator dyes were engineered with AM esters to offer a more convenient method for loading hydrophilic dyes into cells.

Intracellular esterases then cleave the AM group and trap the dye inside cells. This method of dye loading also effectively concentrates Ca^{2+} indicators inside cells such that a bath concentration of 1-5 μM results in a cytosolic concentration of greater than 100 μM . Another advantage of using AM-linked Ca^{2+} dyes is that subcellular compartments can be labeled.

1.7 Live cell imaging:

Live cell imaging is the study of cellular structure and function in living cells via microscopy. It enables the visualization and quantitation of dynamic cellular processes in real time. The ability to study cellular and subcellular structure, function, and organization in living systems aids in the development of assays that are more biologically relevant and can better predict the human response to new drug candidates.

Live cell imaging encompasses a broad range of topics and biological applications—whether it is performing long-term kinetic assays or fluorescently labeling live cells. Live cell imaging is a fundamental research tool in cell biology labs and in a wide variety of industries, it has also led to the discovery of drug targets and candidates as well as the molecular mechanisms involved in diseases. Critical for these researchers, is the ability to develop assays that can best mimic the in vivo nature of cells.

1.7.1 Benefits of imaging live cells include:

- Monitoring live cells over time provides more than a snapshot of what is occurring in the cells while allowing for the visualization of transient events that

may be missed in end-point assays and revealing optimal time-points for end-point assays.

- Tight regulation of environmental conditions ensures that the cellular structures and processes being studied are in their native physiological state
- Imaging live cells in their natural state minimizes artifacts that can arise from other imaging techniques, such as cell fixation and immunostaining.
- The localization and transport of cellular biomolecules along with the progression of multiple pathways can be investigated simultaneously in real-time.
- Acquiring images laterally, axially, and temporally enables the generation of 4D images and data
- Live cell imaging of molecular dynamics generates qualitative and quantitative data that can't be gained from other biochemical methods.

1.72 The Live Cell Imaging Microscope (Confocal Laser Microscope)

Micro Confocal system is a high-content solution that can switch between widefield and confocal imaging of fixed and live cells. It can capture high quality images of whole organisms, thick tissues, 2D and 3D models, and cellular or intracellular events. The spinning disc confocal and camera enable imaging of fast and rare events like cardiac cell beating and stem cell differentiation. With MetaXpress software and flexible options like water immersion objectives to choose from, the system enables many confocal imaging applications from 3D assay development to screening.

Most modern widefield epifluorescence, spinning disk confocal or TIRF microscope setups rely on a similar set of optical and mechanical components, and all imaging modalities are often used for live cell imaging.

The most important hardware factors that should be considered in the design of a live cell imaging microscope to limit light exposure as much as possible are :

- **Excitation and Emission light path:** The wavelengths of excitation and emission filters should be optimized to match the fluorophore used to limit unnecessary light exposure and optimize detection of fluorophore emission
- **Shutters:** Fast, motorized shutters should be used to turn off the excitation light when not needed to take an image. It is particularly important to note that software-controlled shutters often have a significant overhead.
- **Objective lens:** specimen irradiance increases drastically with magnification. Thus, to limit photodamage to the specimen, the lowest magnification should be used as determined by the experimental question. However, it is important to note that sufficient sampling of the microscope optical resolution in many cases requires 100× magnification
- **Camera:** To detect dim fluorescent signals, it is essential to use cooled scientific grade cameras with the lowest readout noise available. Lower noise allows detection of dimmer signal. While Interline CCD cameras have historically shown the best performance for live cell imaging, the camera field has developed rapidly in recent years

1.73 Microscope Environmental Control

Cultured cells and tissues will only behave normally in a physiological environment, and control of factors such as temperature and tissue culture medium composition are thus critically important to obtaining meaningful data in live cell imaging experiments. The conditions required to successfully maintain cell health on the microscope stage obviously

depend on the organism, to maintain environmental control with a focus on live cell imaging of mammalian cell types we have to focus on:

✓ **Temperature**

The most basic level of environmental control is maintaining correct temperature to ensure that observed cell dynamics are an accurate representation of in vivo cell behavior. For cells from warm-blooded animals, the specimen thus needs to be warmed. Although the most commonly used temperature is 37°C for mammalian cell line.

2 Methods and Materials

2.1 Methods

2.11 Adenosine Triphosphate

In this project ATP was used due to its role as a ubiquitous extracellular messenger elevated in the tumor microenvironment. ATP regulates cell functions by acting on purinergic receptors (P2X and P2Y) and activating a series of intracellular signaling pathways. There is a growing interest in the role of ATP in the development of cancer. ATP, well known as an intracellular molecular energy source, it also functions as an extracellular messenger. ATP receptors are purinergic receptors (P2 receptors) and include the ligand-gated ion channel family of P2 receptors (P2X1-7) as well as the G protein-coupled receptor (GPCR) family of P2 receptors. Activation of P2X receptors, which are nonselective cation channels formed by three homomeric or heteromeric P2X subunits, directly results in Na⁺ and Ca²⁺ influx through the cell plasma membrane, leading to membrane depolarization, which in turn activates voltage-gated Na⁺ and Ca²⁺ channels and causes the firing of action potentials. Activation of P2Y receptors, which are GPCRs, increases cytosolic free Ca²⁺ concentration by inducing Ca²⁺ release from intracellular stores (e.g., sarcoplasmic or endoplasmic reticulum) and Ca²⁺ influx through store-operated (SOC) and/or receptor-operated (ROC) Ca²⁺ channels.

P2X and P2Y signaling is not only responsible for inducing action potentials in excitable cells. It also has been implicated in cell proliferation, differentiation, and apoptosis in non-excitabile cells.

2.12 DMEM

The majority of the experiments in Cancer research which are currently ongoing are still performed in historic cell culture media, some of which were formulated at least half a century ago, and whose composition clearly differs from the nutritional environment that cells withstand in Tumors. For example, Eagles minimal essential medium, MEM, Dulbecco's modified eagle medium (DMEM), were designed to supply cancer cells with only those nutrients essential for their continuous proliferation. These are widely used and in 2016 more than half of the published cell culture-based studies employed these methods.

DMEM is a widely used basal medium for supporting the growth of many different mammalian cells. Cells successfully cultured in DMEM include primary fibroblasts, neurons, glial cells, HUVECs, and smooth muscle cells, as well as cell lines such as HeLa, 293, Cos-7, and PC-12.

Modification of MEM containing increased level of amino acids and vitamins supports a wide range of cell types including hybridomas. Many modifications of Eagle's Medium have been developed since the original formulation appeared in the literature.

DME is a modification of Basal Medium Eagle (BME) that contains a 4-fold higher concentration of amino acids and vitamins, as well as additional supplementary components. The original DME formula, first reported for culturing embryonic mouse cells, contained 1,000 mg/L of glucose. An alteration with 4,500 mg/L glucose is optimal in cultivating certain cell types.

2.13 Fetal Bovine Serum

Fetal bovine serum (FBS) is the liquid fraction of clotted blood from fetal calves, depleted of cells, fibrin and clotting factors, but containing a large number of nutritional and macromolecular factors essential for cell growth. Bovine serum albumin is the major component of FBS. Growth factors in FBS are essential for the maintenance and growth of cultured cells. FBS also contains a variety of small molecules like amino acids, sugars, lipids, and hormones.

FBS is used in a wide range of applications. One of the primary uses of FBS is in eukaryotic cell culture, with concentrations up to 20% or even higher, where it provides many essential nutrients and growth factors that facilitate cell survival and proliferation.

FBS is best stored frozen, between -5 to -20°C, and can be thawed at a temperature between 2 to 8°C. It is often useful to aliquot and freeze the serum in smaller portions, often 50 ml tubes, to avoid many freeze and thaw cycles. Occasionally, some aliquots of FBS remain in a liquid at freezing temperatures. This is due to the lack of a nucleation center (particulate matter) for the crystallization (freezing) to start. And flicking the tubes with finger, usually solidify almost instantly.

It is common to have some precipitate after thawing. The precipitates, likely due to denaturation of some of the serum proteins, can be cleared by brief centrifugation, and this generally does not affect the quality of the serum.

2.14 Phosphate Buffered Saline

Phosphate-buffered saline (PBS) is a buffer solution used in biological research. It is a water-based salt solution containing sodium phosphate, sodium chloride and, in some formulations, it contains potassium chloride and potassium phosphate. The osmolality and ion concentrations of the solutions match those of the human body (isotonic) and are non-toxic to most cells.

pre-cooled PBS are used to wash the surface of tissues and internal debris or cell culture medium to prevent the interference of endogenous IgG or culture medium

2.15 Trypsin

For trypsin digestion of peptides, use a ratio of about 1:10 to 1:20 for trypsin peptide. The typical use for this product is in removing adherent cells from a culture surface. The concentration of trypsin necessary to dislodge cells from their substrate is dependent primarily on the cell type and the age of the culture. Trypsin have also been used for the re-suspension of cells during cell culture, in proteomics research for digestion of proteins and in various in-gel digestions. Additional applications include assessing crystallization by membrane-based techniques and in a study to determine that protein folding rates and yields can be limited by the presence of kinetic traps.

Trypsin cleaves peptides on the C-terminal side of lysine and arginine residues. The rate of hydrolysis of this reaction is slowed if an acidic residue is on either side of the cleavage site and hydrolysis is stopped if a proline residue is on the carboxyl side of the cleavage site. The optimal pH for trypsin activity is 7-9. Trypsin can also act to cleave ester and amide linkages of synthetic derivatives of amino acids. EDTA is added to trypsin solutions as a chelating agent that neutralizes calcium and magnesium ions that obscure the peptide bonds on which trypsin acts. Removing these ions increases the enzymatic activity.

2.16 Trypan blue

Trypan Blue Staining Solution is a vital stain that colors dead tissues or cells blue. Since cells are very selective, in a viable cell, the trypan blue will not pass through the membrane; however, it traverses the membrane in a dead cell. Hence, dead cells are shown as a distinctive blue color under a microscope. The method cannot distinguish between necrotic and apoptotic cells.

2.17 Pluronic f127

Introduction Pluronic F-127 is a nonionic, surfactant polyol (molecular weight approximately 12,500 daltons) that has been found to facilitate the solubilization of water-insoluble dyes and other materials in physiological media.

Pluronic F-127 has been used to help disperse acetoxymethyl (AM) esters of fluorescent ion indicators such as fura-2, indo-1, fluo-3 and SBFI; it appears to be required with SBFI-AM or PBFI-AM, and optional with other indicators. Pluronic F-127 may also be useful for dispersing other lipophilic probes. Appropriate controls should be performed to make certain that Pluronic F-127 is not altering the membrane properties of the cell.

Applications

The experimental conditions for loading cells with AM esters vary with cell type due to differences both in probe uptake and in the intracellular esterase activity required for hydrolysis of the AM esters. Solutions of the AM esters in DMSO must be kept anhydrous since the solvent will readily take up moisture, leading to loss of cell-loading efficacy. Pluronic F-127 should be added only to working solutions. Typically, a small volume of the AM ester, dissolved at 1–5 mM in DMSO, is mixed with the 20% (w/v) Pluronic F-127 stock solution in DMSO at a ratio of 1:1 immediately before use. The solution of AM ester and Pluronic F-127 is then diluted into the cell-loading buffer to achieve a final AM ester concentration of between 1 μ M and 10 μ M and the cells are incubated for between 10 minutes and 1 hour. The final concentration of Pluronic F-127 is normally kept at or below 0.1%. More weakly fluorescent indicators.

2.2 Concentration of ATP Solution

different concentrations of ATP were used to check which concentration will induce apoptosis. Starting with the concentration of :

1. 20 micromolar.
2. 30 micromolar.
3. 40 micromolar.
4. 50 micromolar.
5. 70 micromolar.
6. 100 micromolar.

2.3 Used Dyed for measuring Cell Death

Then, many different dyes used to check how ATP kill the cells.

2.31 For Fluorescent dyes, in this project propidium iodide which is a Fluorescent cell staining used. PI can be viewed using rhodamine (red) filter. PI has a fluorescent excitation maximum of 493 nm, and an emission maximum of 636 nm. Cells will only be stained if the membrane has been permeated, either naturally (non-viable cells) or with detergents (for fluorescent staining). When PI does gain access to nucleic acids and intercalates, its fluorescence increases dramatically and is therefore used to identify dead cells.

The Trypan Blue viability test is a widely used technique to determine the cell number and the culture viability.

Calcium ions (Ca^{2+}) play vital cellular physiology roles in signal transduction pathways, in neurotransmitter release, in contraction of all muscle cell types, as enzyme cofactors, and in fertilization. Extracellular calcium is also important for maintaining the potential difference across excitable cell membranes, as is well known as a requirement for proper bone formation. Analyzing calcium flux using live cell calcium imaging techniques is important to understanding cellular function and dysfunctions that may be components of disease.

chemical calcium indicators and sensors are small molecules that bind calcium ions via chelation. Many are based on widely-used calcium chelators like EGTA, (ethylene glycol-bis (β -aminoethyl ether), or on chelators with enhanced calcium ion (Ca^{2+}) specificity or pH stability, such as BAPTA (1,2-bis(o-amino phenoxy) ethane-N,N,N',N'-tetra acetic acid). These dyes are often modified with acetoxymethyl esters (AM), in order to render the molecule lipophilic and to allow easy entrance into the cell. Once inside the cell, cellular esterases will free the carboxyl groups, enabling Ca^{2+} by the indicator. Binding of a Ca^{2+} ion to a fluorescent indicator molecule leads either to an increase in quantum yield of fluorescence or an emission/excitation wavelength shift.

2.32 Traditional and Novel Calcium Imaging Probes

Fura-2: A UV light-excitable, ratio metric Ca^{2+} indicator that is a common dye for ratio-imaging microscopy

Indo-1: A UV light-excitable Ca^{2+} indicator that is the preferred calcium sensor for flow cytometry that uses a single laser for excitation.

Quin-2: Displays high selectivity for calcium. This calcium indicator is not affected by sodium gradients, membrane potential range, or intracellular pH, and displays high affinity for Ca^{2+} ions. Quin-2 is sensitive enough to monitor low levels of calcium, such as those found in resting cells

Fluo-3: A fluorescence indicator of intracellular calcium (Ca^{2+}) used in flow cytometry and confocal laser scanning microscopy.

Fluro-4 AM: Then FLURO-4AM used to measure calcium concentrations inside living cells and is often used for high-throughput screening of receptor ligands and calcium permeable ion channels.

Membrane-permeant AM ester form of Fluo-4 that can enter into cells via incubation. Fluo-4 AM ester itself does not bind Ca^{2+} , but it is readily hydrolyzed to Fluo-4 by endogenous esterases once inside cells. Fluo-4 AM ester is often used to measure intracellular calcium in high throughput drug screening. The green-fluorescent calcium

indicator, Fluo-4, is an improved version of the calcium indicator, Fluo-3 with the two chlorine substituents replaced by fluorine, which results in increased fluorescence excitation at 488 nm that gives higher fluorescence signal. Fluo-4 has its absorption maximum at 494 nm, thus making it excitable by the argon-ion laser. Also is essentially a brighter, more photostable derivative of fluo-3. Its Ca^{2+} affinity is a little lower ($K_d \sim 345$ nM) and its absorption maximum is shifted ~ 12 nm compared to fluo-3 and Lower concentrations of dye can yield almost double the amount of fluorescence, which is advantageous in cell lines plated at lower densities. As importantly, fluo-4 has very low background absorbance and lower dye concentrations require shorter incubation times. Fluo-4 is essentially nonfluorescent without Ca^{2+} present, but the fluorescence increases at least 100 times on Ca^{2+} binding. Also, because Fluo-4 binds Ca^{2+} more weakly (higher K_d) than do fura-2 and indo-1, it is more useful for measuring high transient Ca^{2+} concentration during Ca^{2+} spikes.

Fluo-4 AM ester can be used to detect intracellular free calcium by fluorescence microscopy, flow cytometry, or fluorescence microplate reader.

2.4 Types of Used Chips

IBIDI 8 wells chamber

The ibidi product family is comprised of a variety of μ -Slides and μ -Dishes, which have all been designed for high-end microscopic analysis of fixed or living cells. The high optical quality of the material is similar to that of glass, so we can perform all kinds of fluorescence experiments with uncompromised resolution and choice of wavelength. For the experiments I used the μ -Slide 8 Well is an array of 8 square fields where cells can be cultivated and, subsequently, investigated with microscopical methods. This open μ -Slide (chambered coverslip) with 8 wells is intended for immunofluorescence, live cell imaging, and high-end microscopy. It is a cell culture chamber for observation of the sample through the coverslip-like bottom using high resolution microscopy. Also, a microscopy slide for brilliant cell imaging thanks to the low thickness variability of the coverslips' glass. For Cost-effective experiments using small numbers of cells and low volumes of reagent.



45-8-well-chamber-removable @ ibidi.com. (n.d.). <https://ibidi.com/chamber-slides/45-8-well-chamber-removable.html>

Material

ibidi μ -Slides, μ -Dishes, and μ -Plates are made of a plastic that has the highest optical quality. The polymer coverslip on the bottom exhibits extremely low birefringence and autofluorescence, similar to that of glass. Also, it is not possible to detach the bottom from the upper part. The μ -Slides, μ -Dishes, and μ -Plates are not autoclavable, since they are only temperature-stable up to 80°C/175°F. And the gas exchange between the medium and incubator's atmosphere occurs partially through the polymer coverslip, which should not be covered

Coating

In short, specific coatings are possible following this protocol:

Prepare the coating solution according to the manufacturer's specifications or reference. Then apply 300 μ l and leave at room temperature for at least 30 minutes. After that, Aspirate the solution and wash with the recommended protein dilution buffer. Finally, the μ -Slide 8 Well is ready to be used.

Applications:

- Cultivation and high-resolution microscopy of cells
- Fluorescence microscopy of living and fixed cells
- Immunofluorescence_staining
- Live cell imaging over extended time periods

- Transfection assays
- Differential interference contrast (DIC) when using a DIC lid

Specifications:

- Outer dimensions (w x l) is 25.5 x 75.5 mm²
- Number of wells is 8 wells
- Dimensions of wells (w x l x h) is 9.4 x 10.7 x 6.8 mm³
- Volume per well is between 300-400 µl
- Total height with lid is 8mm
- Growth area per well is 1.0 cm²
- Coating area per well is 2.20 cm²

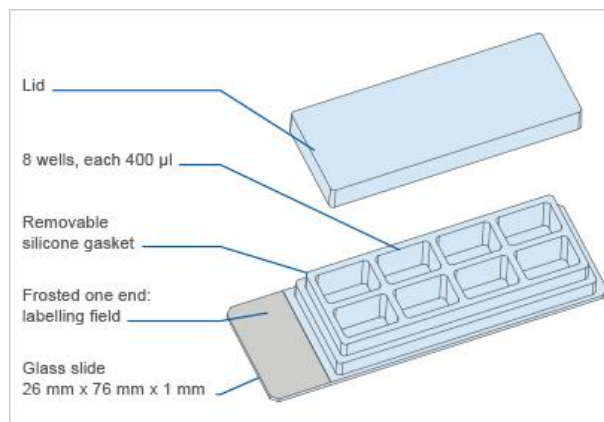

45-8-well-chamber-removable @ ibidi.com. (n.d.). <https://ibidi.com/chamber-slides/45-8-well-chamber-removable.html>

Technical features

- Chambered coverslip with 8 independent wells and a non-removable polymer coverslip-bottom
- ibiTreat (tissue culture-treated) surface for optimal cell adhesion
- Imaging chamber slide with excellent optical quality for high-end microscopy
- Closely fitting lid
- Compatible with staining and fixation solutions
- Biocompatible plastic material—no glue, no leaking
- Also available as an adhesive version without a bottom: sticky-Slide 8 Well
- Also available with a Glass Coverslip Bottom: µ-Slide 8 Well Glass Bottom for special microscopic applications
- Additional version available with a 500 µm grid: µ-Slide 8 Well Grid-500

2.41 Application Examples

Immunofluorescence

The ibidi μ -Slide 8 Well allows for standard immunofluorescence protocols to be employed without the use of coverslips in an all-in-one chamber. All steps (e.g., cell cultivation, fixation, staining, and imaging) are carried out in the open well geometry. After staining, the sample can be observed through the coverslip bottom using high-resolution microscopy. The closely fitting lid prevents evaporation and allows for long-term assays.

2.42 Live cell imaging

The μ -Slide 8 Well enables high-resolution live cell imaging using different brightfield and fluorescence techniques. Here, live cell microscopy was performed using the μ -Slide 8 Well in the ibidi Heating System, Universal Fit, for 1 Chamber on a Nikon Eclipse TIE inverted microscope.

2.5 Cell Culture

Cell culture is the complex and delicate process of maintaining and/or growing dispersed cells, which have been isolated from either tissue or serum, under controlled conditions, generally outside of the respective natural environment, and more commonly upon the surface of a cell culture plate immersed in nutrient rich growth media. With the exception of some primary cell lines that have been derived from tumor tissue, most primary cell cultures are incapable of indefinite expansion given that these cells tend to undergo only a finite number of population doublings before succumbing to senescence, at which point the general viability of the cells is retained but the ability to undergo further replications is lost. Those tumor-derived primary cell lines that demonstrate the ability to avoid senescence and proliferate indefinitely, do so through the accumulation of either coincidental or manufactured mutations that cooperatively allow for unrestrained cell proliferation that defies the normal constraints of cellular division, such as telomerase production, decreased density-dependent

growth inhibition and anchorage-independence. The use of cell cultures, which can be maintained in states of both suspension and adherence in order to mimic the respective environments from which those cells were initially removed, has proven to be fundamental to advancements in the disciplines of tissue culturing and engineering, the manufacturing of viral vaccines, and the production of both proteins and antibodies.

2.51 Aseptic Work Area

The major requirement of a cell culture laboratory is the need to maintain an aseptic work area that is restricted to cell culture work. Although a separate tissue culture room is preferred, a designated cell culture area within a larger laboratory can still be used for sterile handling, incubation, and storage of cell cultures, reagents, and media. The simplest and most economical way to provide aseptic conditions is to use a cell culture hood.

The cell culture hood provides an aseptic work area while allowing the containment of infectious splashes or aerosols generated by many microbiological procedures. Three kinds of cell culture hoods, designated as Class I, II and III, have been developed to meet varying research and clinical needs.

Air-Flow Characteristics of Cell Culture Hoods Cell culture hoods protect the working environment from dust and other airborne contaminants by maintaining a constant, unidirectional flow of HEPA-filtered air over the work area. The flow can be horizontal, blowing parallel to the work surface, or it can be vertical, blowing from the top of the cabinet onto the work surface. Depending on its design, a horizontal flow hood provides protection to the culture (if the air flowing towards the user) or to the user (if the air is drawn in through the front of the cabinet by negative air pressure inside). Vertical flow hoods, on the other hand, provide significant protection to the user and the cell culture.

Cell culture hood should be large enough to be used by one person at a time, be easily cleanable inside and outside, have adequate lighting, and be comfortable to use without requiring awkward positions. Keeping the workspace in the cell culture hood clean and uncluttered and keep everything in direct line of sight. Disinfect each item placed in the cell culture hood by spraying them with 70% ethanol and wiping clean. The arrangement of items within the cell culture hood usually adheres to the following right-handed convention, which can be modified to include additional items used in specific applications.

- A wide, clear workspace in the center with your cell culture vessels
- Pipettor in the front right, where it can be reached easily
- Reagents and media in the rear right to allow easy pipetting
- Tube rack in the rear middle holding additional reagents
- Small container in the rear left to hold liquid waste

The purpose of the incubator is to provide the appropriate environment for cell growth. The incubator should be large enough for your laboratory needs, have forced air circulation, and have temperature control to within $\pm 0.2^{\circ}\text{C}$. Stainless steel incubators allow easy cleaning and provide corrosion protection, especially if humid air is required for incubation. Although the requirement for aseptic conditions in a cell culture incubator is not as stringent as that in a cell culture hood, frequent cleaning of the incubator is essential to avoid contamination of cell cultures.

There are two basic types of incubators, dry incubators and humid CO₂ incubators. Dry incubators are more economical but require the cell cultures to be incubated in sealed flasks to prevent evaporation. Placing a water dish in a dry incubator can provide some humidity, but they do not allow precise control of atmospheric conditions in the incubator. Humid CO₂ incubators are more expensive but allow superior control of

culture conditions. They can be used to incubate cells cultured in Petri dishes or multi-well plates, which require a controlled atmosphere of high humidity and increased CO₂ tension.

A cell counter is essential for quantitative growth kinetics, and a great advantage when more than two or three cell lines are cultured in the laboratory. The Automated Cell Counter is a bench-top instrument designed to measure cell count and viability (live, dead, and total cells) accurately and precisely in less than a minute per sample, using the standard Trypan Blue uptake technique. Using the same amount of sample that you currently use with the hemocytometer, the Countess® Automated Cell Counter takes less than a minute per sample for a typical cell count and is compatible with a wide variety of eukaryotic cells

2.52 Aseptic Technique

Successful cell culture depends heavily on keeping the cells free from contamination by microorganisms such as bacterial, fungi, and viruses. Non-sterile supplies, media, and reagents, airborne particles laden with microorganisms, unclean incubators, and dirty work surfaces are all sources of biological contamination. Aseptic technique, designed to provide a barrier between the microorganisms in the environment and the sterile cell culture, depends upon a set of procedures to reduce the probability of contamination from these sources. The elements of aseptic technique are a sterile work area, good personal hygiene, sterile reagents and media, and sterile handling.

Sterile Work Area

- The cell culture hood should be properly set up and be located in an area that is restricted to cell culture that is free from drafts from doors, windows, and other equipment, and with no through traffic.

- The work surface should be uncluttered and contain only items required for a particular procedure; it should not be used as a storage area.
- Before and after use, the work surface should be disinfected thoroughly, and the surrounding areas and equipment should be cleaned routinely.
- For routine cleaning, wipe the work surface with 70% ethanol before and during work, especially after any spillage.
- Sometimes it may use ultraviolet light to sterilize the air and exposed work surfaces in the cell culture hood between uses.
- Using a Bunsen burner for flaming is not necessary nor recommended in a cell culture hood.
- Leave the cell culture hood running at all times, turning them off only when they will not be used for extended periods of time.

Personal Hygiene

Wash hands before and after working with cell cultures. In addition to protecting you from hazardous materials, wearing personal protective equipment also reduces the probability of contamination from shed skin as well as dirt and dust from your clothes.

Sterile Reagents and Media Commercial reagents and media undergo strict quality control to ensure their sterility, but they can become contaminated while handling. Follow the guidelines below for sterile handling to avoid contaminating them. Always sterilize any reagents, media, or solutions prepared in the laboratory using the appropriate sterilization procedure.

2.6 Thawing frozen cells

The thawing procedure is stressful to frozen cells and using good technique and working quickly ensures that a high proportion of the cells survive the procedure. As with other cell culture procedures, we recommend that you closely follow the instructions provided with your cells and other reagents for best results.

- Thaw frozen cells rapidly (< 1 minute) in a 37°C water bath.
- Dilute the thawed cells slowly, using a pre-warmed growth medium.
- Plate thawed cells at high density to optimize recovery.
- use proper aseptic technique and work in a laminar flow hood.
- wear personal protective equipment, including a face mask or goggles. Cryovials stored in liquid-phase present a risk of explosion when thawed.
- Some freezing media contain DMSO, which is known to facilitate the entry of organic molecules into tissues. Handle reagents containing DMSO using equipment and practices appropriate for the hazards posed by such materials.

Protocol for Thawing Frozen Cells The following protocol describes a general procedure for thawing cryopreserved cells. For detailed protocols, always refer to the cell-specific product insert.

1. Remove the cryovial containing the frozen cells from liquid nitrogen storage and immediately place it into a 37°C water bath.
2. Quickly thaw the cells (< 1 minute) by gently swirling the vial in the 37°C water bath until there is just a small bit of ice left in the vial.

3. Transfer the vial into a laminar flow hood. Before opening, wipe the outside of the vial with 70% ethanol.
4. Transfer the thawed cells dropwise into the centrifuge tube containing the desired amount of pre-warmed complete growth medium appropriate for your cell line.
5. Centrifuge the cell suspension at approximately for 5–10 minutes. The actual centrifugation speed and duration varies depending on the cell type.
6. After the centrifugation, check the clarity of supernatant and visibility of a complete pellet. Aseptically decant the supernatant without disturbing the cell pellet.
7. Gently resuspend the cells in complete growth medium and transfer them into the appropriate culture vessel and into the recommended culture environment.

Trypan blue

1. Determine the cell density of your cell line suspension using a hemocytometer.
2. Prepare a 0.4% solution of trypan blue in buffered isotonic salt solution, pH 7.2 to 7.3 (i.e., phosphate-buffered saline).
3. Add 0.1 mL of trypan blue stock solution to 1 mL of cells.
4. Load a hemocytometer and examine immediately under a microscope at low magnification.
5. Count the number of blue staining cells and the number of total cells. Cell viability should be at least 95% for healthy log-phase cultures. % viable cells = $[1.00 - (\text{Number of blue cells} \div \text{Number of total cells})] \times 100$ To calculate the number of viable cells per mL

of culture, use the formula below. Remember to correct for the dilution factor. Number of viable cells $\times 10^4 \times 1.1 =$ cells/mL culture

2.7 Significance of Cell Culture

Cell culture is an important technique in both cellular and molecular biology given that it provides the best platform for studying the normal physiology and biochemistry of cells. A cell is the basic structural, functional and biological unit of all living things.

In order to understand an organism or given tissues, it is important to understand how its cells work. Through cell culture, this becomes possible especially due to the fact the primary cells resemble the parental cells from the organism/tissue.

Whatever is learnt about the cells in vitro is representative of what is happening to the organism/tissue. This makes cell culture significantly important for vaccine development, screening (drugs etc) and diagnosis of given diseases/conditions.

Steps

1. Remove spent media from the culture vessel
2. Wash with Cells with PBS.
3. Add the pre-warmed dissociation reagent such as trypsin. Gently rock the container to get complete coverage of the cell layer.
4. Incubate the culture vessel at room temperature for approximately 2 minutes.
5. Add equivalent of 2 volumes of pre-warmed complete growth medium.
6. Dispense the medium by pipetting over the cell layer surface several times.
7. Split the cells into Two or Three flasks containing complete media.
8. Incubate the cells.

9. Monitor the culture every 30- 48 hours and check for confluency (when cells completely cover the surface of the culture) - However, this is largely dependent on the type of cells.

Solutions of the AM esters in DMSO was kept anhydrous since the solvent will readily take up moisture, leading to loss of cell-loading efficacy. Then, Pluronic F-127 were added only to working solutions. Typically, a small volume of the AM ester, dissolved at 1–5 mM in DMSO, is mixed with the 20% (w/v) Pluronic F-127 stock solution in DMSO at a ratio of 1:1 immediately before use.

The solution of AM ester and Pluronic F-127 is then diluted into the cell-loading buffer to achieve a final AM ester concentration of between 1 μ M and 10 μ M and the cells are incubated for between 10 minutes and 1 hour.

The final concentration of Pluronic F-127 is normally kept at or below 0.1%. More weakly fluorescent indicators. In general, it is desirable to use the minimum amount of AM ester needed to achieve adequate fluorescence signal to noise levels. Loading may be done at any temperature that is tolerable for the cells. The incubation temperature generally affects the extent of intracellular dye compartmentalization. After labeling, the cells are washed with fresh medium before beginning the experiment.

Results:

Calcium imaging is a very powerful approach in understanding Ca^{2+} signals, and their temporal and spatial characteristics in cells and tissues also, Ca^{2+} imaging is a very important allowing measurement of the intracellular free Calcium concentration change of the calcium influx simultaneously from multiple sites, including different cells in a network or different compartments within a cell. Using confocal microscopy, the improved spatial resolution permits recordings from sub-micron structures such as axonal terminals or dendritic spines.

The method of calcium imaging is often combined with electrode recordings to correlate electrical and chemical signals or to investigate Ca^{2+} signals following an electrical stimulation. To obtain information on electrical activity at the same spatial resolution, Ca^{2+} imaging must be combined with membrane potential imaging. Similarly, stimulation of subcellular compartments requires photostimulation. Thus, combining Ca^{2+} imaging with an additional optical technique facilitates the study of a number of physiological questions.

In all the experiments Pluronic F-127 was used which is a nonionic, surfactant polyol that has been found to facilitate the solubilization of water-insoluble dyes and other materials in physiological media. It has been used to help disperse acetoxymethyl (AM) esters of fluorescent ion indicators such as fura-2, indo-1, fluo-3 and fluo-4. Pluronic F-127 may also be useful for dispersing other lipophilic probes.

Appropriate controls were performed to make certain that Pluronic F-127 is not altering the membrane properties of the cell.

The experimental conditions for loading cells with AM esters vary with cell type due to differences both in probe uptake and in the intracellular esterase activity required for hydrolysis of the AM esters.

3.1 Comparison between different concentrations of ATP

Finally, after loading the cells in the ships the experiments started.

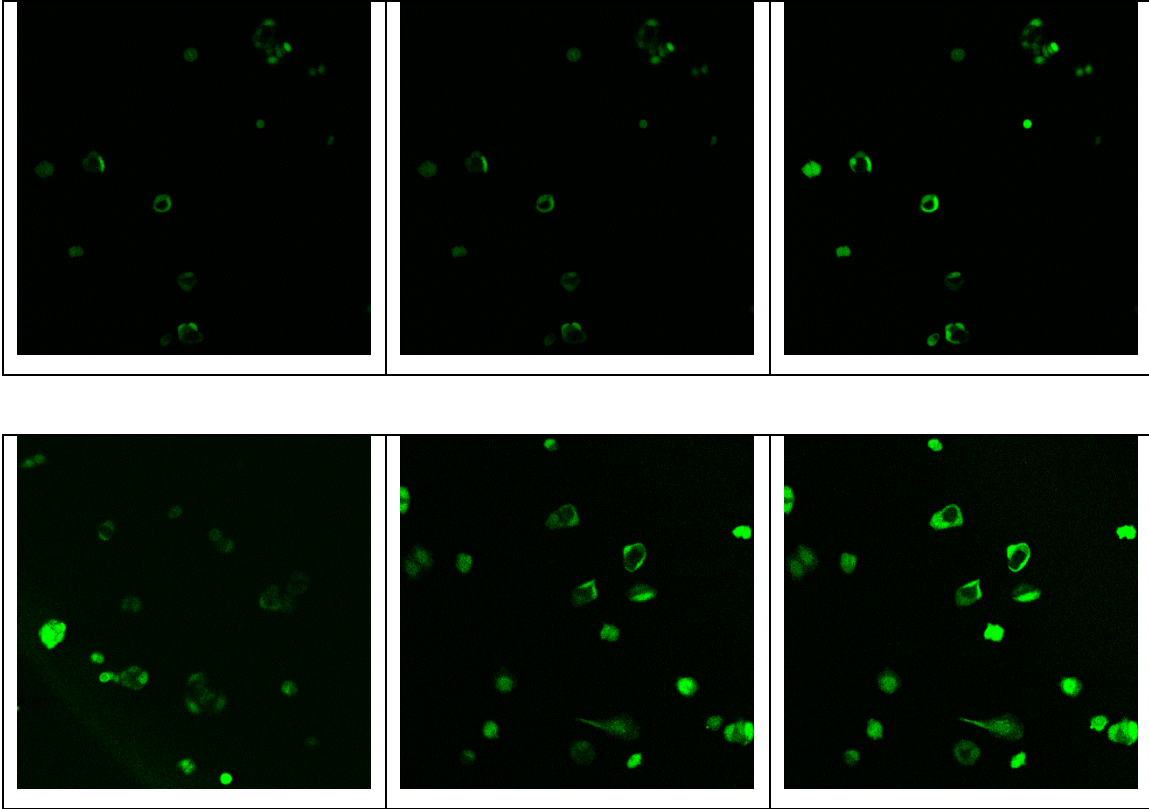

Intracellular calcium mobilization was detected by monitoring fluoro 4-AM fluorescence using kinetic live cell imaging.

Image processing reduced background fluorescence, improving detection and analysis of calcium release.

An increase in intracellular calcium was detected approximately 3 seconds after addition of ATP of 100 micromolar final after the **first stimulation** with ATP.

Peak calcium mobilization for the entire field of cells was reached 15 seconds post-ATP Addition .

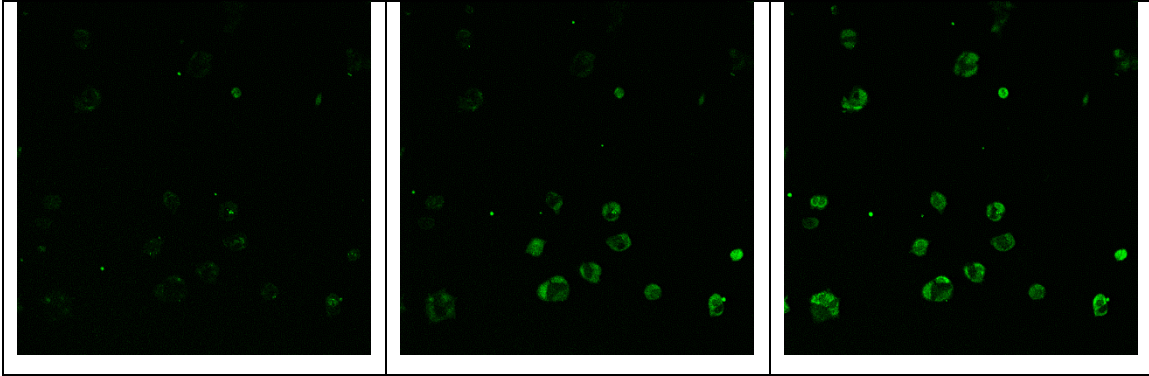

An increase in intracellular calcium was detected approximately 7 seconds after addition of ATP of 70 micromolar final after the **first stimulation** with ATP.

Peak calcium mobilization for the entire field of cells was reached 35 seconds post-ATP addition .

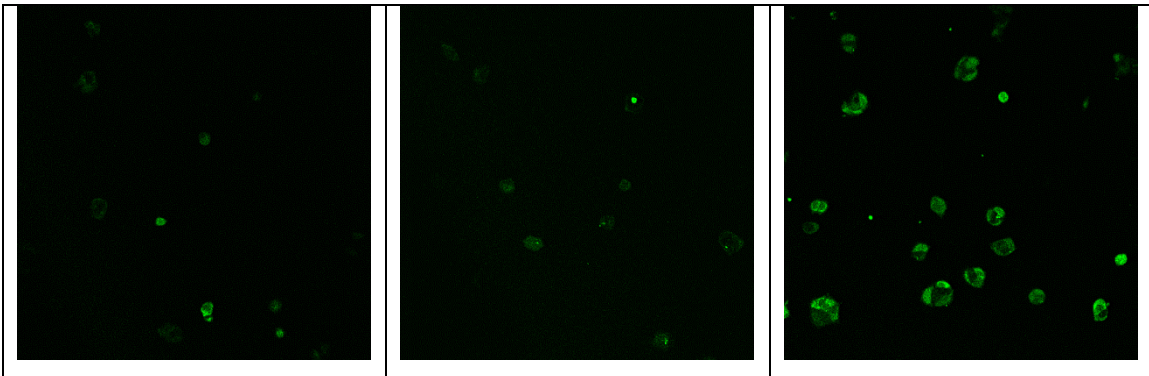

An increase in intracellular calcium was detected approximately 10 seconds after addition of ATP of 50 micromolar final after the **first stimulation** with ATP.

Peak calcium mobilization for the entire field of cells was reached 35 seconds post-ATP addition .

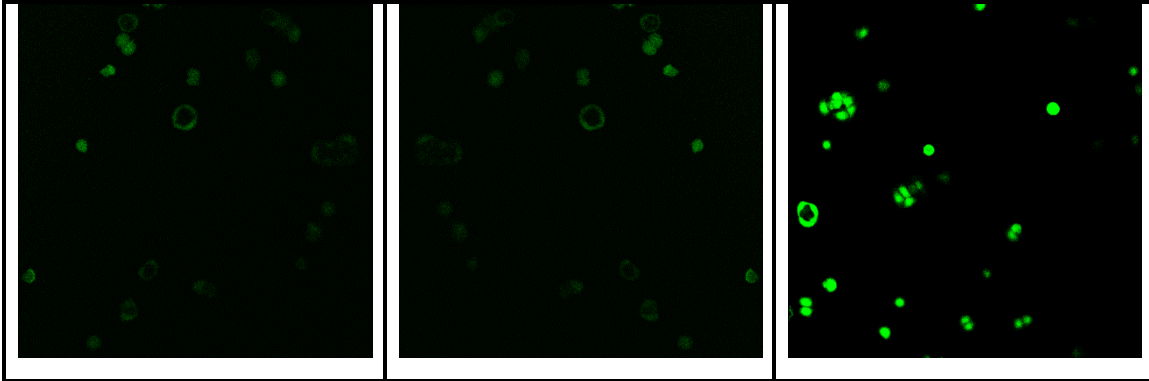

An increase in intracellular calcium was detected approximately 45 seconds after addition of ATP of 40 micromolar final after the **first stimulation** with ATP. Peak calcium mobilization for the entire field of cells was reached 55 seconds post-ATP addition .

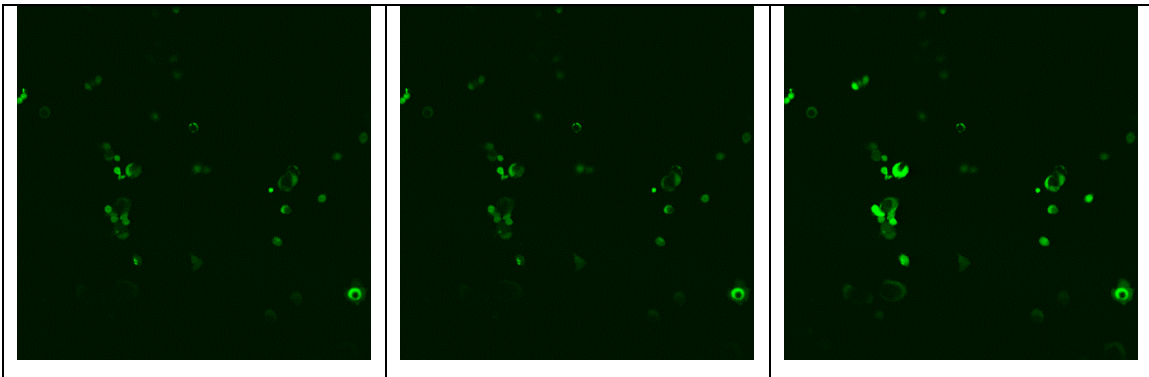

An increase in intracellular calcium was detected approximately 50 seconds after addition of ATP of 30 micromolar final after the **first stimulation** with ATP. Peak calcium mobilization for the entire field of cells was reached 100 seconds post-ATP addition .

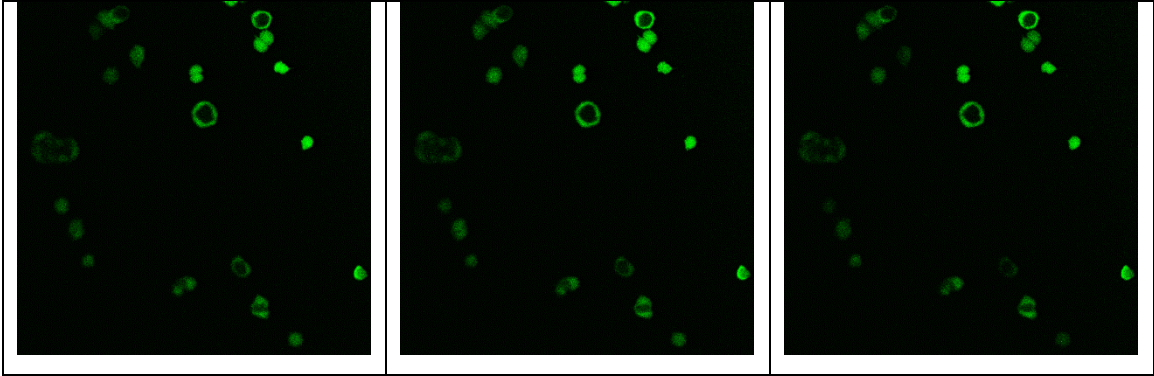

After the first stimulation with the ATP the wells were washed again with PBS second stimulation with ATP, and after 100 minutes the response came again in few cells.

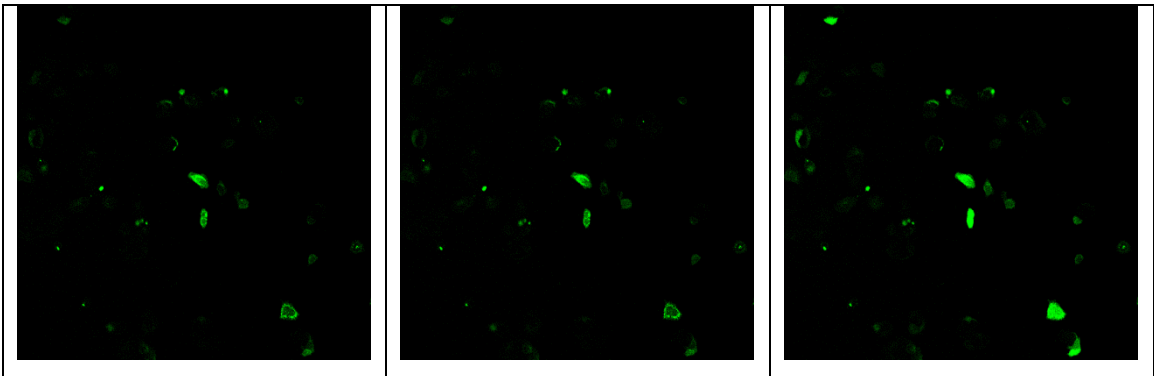

An increase in intracellular calcium was detected approximately 60 seconds after addition of ATP of 20 micromolar final after the **first stimulation** with ATP. Peak calcium mobilization for the entire field of cells was reached 120 seconds post-ATP addition.

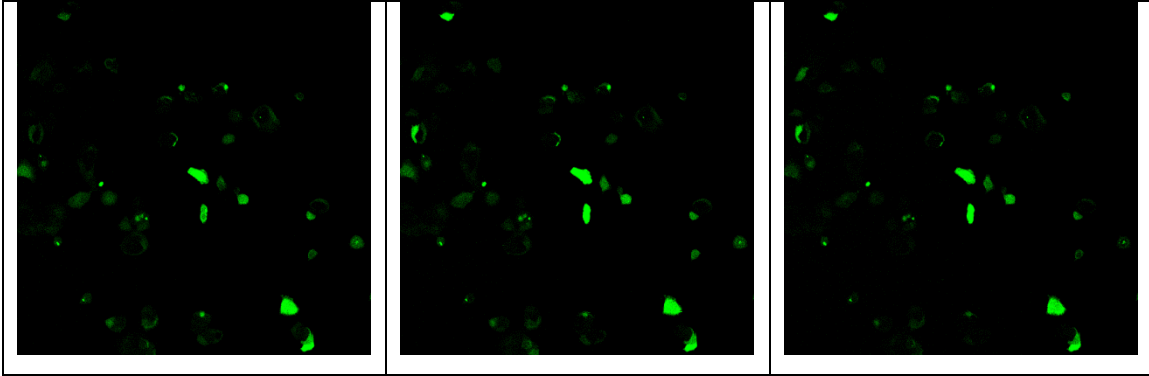

After the first stimulation with the ATP the wells were washed again with PBS second stimulation with ATP, and after 2 minutes the response came again in few cells.

3.3 Release of Intracellular Adenosine Triphosphate

Intracellular adenosine triphosphate (ATP) is released into the extracellular space in response to various stimuli, including shear stress, stretch, hypoxia, inflammation, osmotic swelling, pH, ionizing and nonionizing radiations, ROS, nanoparticles, and cell death, followed by activation of purine 2 (P2) receptors.

The P2 receptors are classified into 2 major subtypes, that is ionotropic P2X receptors and metabotropic P2Y receptors. Various physiological functions are modulated through activation of these receptors. The released ATP is then rapidly metabolized to adenosine diphosphate, adenosine monophosphate, and adenosine by nucleotidases. These metabolites bind with P2X, P2Y, and/or P1 receptors with different affinities. Various ATP release pathways have been reported, including a maxi-anion channel, P2X7 receptor/pore, a volume-sensitive outwardly rectifying chloride channel, a member of the ATP-binding cassette protein family, a gap junction hemi-channel, and vesicular exocytosis.

The ATP released from cells through these pathways activates P2 receptors in an autocrine or a paracrine manner, leading to activation of downstream purinergic signaling/ATP signaling pathways. Outcomes include activation of DNA repair, induction of antioxidants, apoptotic cell death, and so on. Though the latter phenomena are also

observed in cells exposed to grays, involvement of ATP signaling in the radiation-induced effects was not clear.

Conclusion

Extracellular ATP is shown to induce programmed cell death (or apoptosis) in thymocytes and certain tumor cell lines. Some studies indicate that the ATP-induced death of thymocytes and susceptible tumor cells follows morphological changes usually associated with glucocorticoid-induced apoptosis of thymocytes. These changes include condensation of chromatin, blebbing of the cell surface, and breakdown of the nucleus. Cytotoxicity assays using double-labeled cells show that ATP-mediated cell lysis is accompanied by fragmentation of the target cell DNA. The effect is faster with the higher concentrations of ATP, and with a lower concentration is slower while the effect is reversible

The biochemical and morphological changes caused by ATP are preceded by a rapid increase in the cytoplasmic calcium of the susceptible cell. Calcium fluxes by themselves, however, are not sufficient to cause apoptosis, as the pore-forming protein, perforin, causes cell lysis without DNA fragmentation or the morphological changes associated with apoptosis. Taken together, these results indicate that ATP can cause cell death through two independent mechanisms, one of which, requiring an active participation on the part of the cell, takes place through apoptosis.

Extracellular ATP is shown to induce programmed cell death (or apoptosis) in thymocytes and certain tumor cell lines.

This distinct form of cell death plays an essential role in tissue development and homeostasis, and in the elimination of cancerous, virally infected or degenerated cells. Most studies demonstrate that apoptotic stimulation reduced, to a certain extent, the total cellular ATP level. Several studies also found that levels of total ATP were unchanged during early stages of apoptosis.

Such variability in measured ATP levels might be, at least in part, due to differences in the time period of apoptotic stimulation and/or the degree of contamination by cells that have already died and lost ATP.

It should also be noted that ATP may not be uniformly distributed throughout the cell body. Thus, it is likely that the total ATP levels measured do not accurately represent the cytosolic ATP levels. In some studies, they made continuous measurements of the cytosolic ATP level in intact cells throughout the apoptotic process, up to their death. This shows that cytosolic ATP within cells undergoing apoptosis is maintained at a level higher than in control cells even as caspase activation and DNA laddering are occurring during the final stages of cell death.

Some papers suggest that elevation of the cytosolic ATP level is a prerequisite to the apoptotic cell death process.

Finally, the usage of ATP in high concentration (100 micromolar, 70 micromolar) has a toxic effect on MCF-7 Cells and plays an essential role in inducing apoptosis and cell death, in contrast while applying the (40 micromolar, 30 micromolar,20 micromolar) of ATP the period of cells survival is more extended then in the first case.

To conclude the effect of this experiment has turned out to be irreversible with the higher concentrations compared to the reversible effect with the lower concentration

List of Abbreviations and Acronyms

DMEM	Dulbecco's Modified Eagle Medium
MEM	Modified Eagle Medium
DMSO	Dimethyl Sulfoxide
PBS	Phosphate-buffered Saline
FBS	Fetal bovine Serum
FDA	Food and Drug Administration
ATP	Adenosine Triphosphate
ADP	Adenosine Diphosphate
DNA	Deoxyribonucleic acid
P2X receptor	Purinoreceptor 7
P2Y receptor	A family of purinergic G protein-coupled receptors
P1	Adenosine Receptor
SOC	Store operated channels
ROC	Receptor operated channels
MCF-7	Is the acronym of Michigan Cancer Foundation-7
PMCA	Plasma membrane calcium ATPase
ER	Estrogen Receptor
Ca _v 3.2	Voltage gated calcium channel
ORAI1	Store operated Calcium channel
P2X5	Example of Purine Receptors
TRPC1	Transient Receptor Potential Vanilloid 1
TRPM8	Transient Receptor Potential Melastatin 8
TRPM7	Transient Receptor Potential Melastatin 7
TRPV6	Transient Receptor Potential Vanilloid 6
Ca ⁺	Calcium
Na ⁺	Sodium

References

1. <https://www.ncbi.nlm.nih.gov/books/NBK56060/>
2. <https://www.ncbi.nlm.nih.gov/pmc/articles/PMC3385957/>
3. <https://www.ncbi.nlm.nih.gov/books/NBK482286/>
4. Clayton, J., Scientist, P., & Instruments, B. (2017). p p l i c a t i o n o t e
Characterizing Calcium Mobilization using Kinetic Live Cell Imaging.
5. 9157970 @ *www.ncbi.nlm.nih.gov*. (n.d.).
<https://www.ncbi.nlm.nih.gov/pubmed/9157970>
6. <https://www.ncbi.nlm.nih.gov/pmc/articles/PMC2666335/>
7. <https://www.embl.de/eamnet/html/calcium/dyes/fluorescentdyes3.htm>
8. <http://ar.iijournals.org/content/35/6/3147.long>
9. Azimi, I., Roberts-Thomson, S. J., & Monteith, G. R. (2014). Calcium influx pathways in breast cancer: Opportunities for pharmacological intervention. *British Journal of Pharmacology*, 171(4), 945–960.
<https://doi.org/10.1111/bph.12486>
- 10.
11. DeBernardi, M. A., & Brooker, G. (2006). High-Content Kinetic Calcium Imaging in Drug-Sensitive and Drug-Resistant Human Breast Cancer Cells. *Methods in Enzymology*, 414(06), 317–335. [https://doi.org/10.1016/S0076-6879\(06\)14018-5](https://doi.org/10.1016/S0076-6879(06)14018-5)
12. Varghese, E., Samuel, S. M., Sadiq, Z., Kubatka, P., Liskova, A., Benacka, J., Pazinka, P., Kruzliak, P., & Büsselberg, D. (2019). Anti-cancer agents in proliferation and cell death: The calcium connection. *International Journal of Molecular Sciences*, 20(12). <https://doi.org/10.3390/ijms20123017>

13. Jardin, I., Lopez, J. J., Salido, G. M., & Rosado, J. A. (2018). Store-operated Ca²⁺ entry in breast cancer cells: Remodeling and functional role. *International Journal of Molecular Sciences*, 19(12), 1–14. <https://doi.org/10.3390/ijms19124053>
14. [d3e30d81ff38b291af2db8f6563831843ef58ce1 @ www.ncbi.nlm.nih.gov](https://www.ncbi.nlm.nih.gov/pmc/articles/PMC2196283/). (n.d.). <https://www.ncbi.nlm.nih.gov/pmc/articles/PMC2196283/>
15. [f386aa0c34107db252c33ed9c6fcb06cd6cecd35 @ www.ncbi.nlm.nih.gov](https://www.ncbi.nlm.nih.gov/pmc/articles/PMC2666335/)
16. [lm.nih.gov](https://www.ncbi.nlm.nih.gov/pmc/articles/PMC2666335/). (n.d.). <https://www.ncbi.nlm.nih.gov/pmc/articles/PMC2666335/>
17. https://www.elabscience.com/p-pbs_buffer_ph7.4_10_C3%97-126132.html?gclid=CjwKCAjwkoz7BRBPEiwAeKw3qxI0F6Q52mAM7EkW-6tgnOM9IzI1WYSjs9cr8r6Q_hGxuKXVivOH1xoCRBUQAvD_BwE
18. [S2211124719303183 @ www.sciencedirect.com](https://www.sciencedirect.com/science/article/pii/S2211124719303183). (n.d.). <https://www.sciencedirect.com/science/article/pii/S2211124719303183>
19. [216-Confocal-Microscopy @ Ibidi.Com](https://ibidi.com/content/216-confocal-microscopy). (n.d.). <https://ibidi.com/content/216-confocal-microscopy>
20. [11374843 @ www.ncbi.nlm.nih.gov](https://www.ncbi.nlm.nih.gov/pubmed/11374843). (n.d.). <https://www.ncbi.nlm.nih.gov/pubmed/11374843>

21. *1852d4fd23c11e1febd1f661a7dc98f9e29b3467 @ www.physics.emory.edu.*
(n.d.). <http://www.physics.emory.edu/faculty/weeks//confocal/>

22. *897837cd5987094e8fc924f95b65134b53c1839e @ www.mcf7.com.* (n.d.).
<https://www.mcf7.com/cell-culture/>

23. *S0143416019301769 @ www.sciencedirect.com.* (n.d.).
<https://www.sciencedirect.com/science/article/pii/S0143416019301769>

24. *bph @ bspubs.onlinelibrary.wiley.com.* (n.d.).
<https://bspubs.onlinelibrary.wiley.com/doi/full/10.1111/bph.12486>

25. *s13578-018-0223-5 @ cellandbioscience.biomedcentral.com.* (n.d.).
<https://cellandbioscience.biomedcentral.com/articles/10.1186/s13578-018-0223-5>

26. *07e18edf0d9a1a077b2a7b8f356027ae9eb6d2f1 @ www.biotek.com.* (n.d.).
<https://www.biotek.com/resources/application-notes/characterizing-calcium-mobilization-using-kinetic-live-cell-imaging/>

27. *e941e3328da722c50ca58f5d7903f0a10eec650e* @ *www.biotek.com*. (n.d.).
<https://www.biotek.com/resources/application-notes/automated-imaging-assay-for-characterizing-ca2-flux-with-r-geco-biosensor/>
28. *5bff6f7b87e4e3adbd958c64819324bc9145dd62* @ *www.biotek.com*. (n.d.).
<https://www.biotek.com/resources/application-notes/thapsigargin-induced-cellular-stress-response-and-inhibition-of-gq-dependent-calcium-signaling/>
29. *0d8e194ec1883a6c8a4d45a3b34c9cb475ef9b3a* @ *expert.cheekyscientist.com*.
 (n.d.). <https://expert.cheekyscientist.com/microscopy-assays-to-determine-cell-health/>
30. June, C. H., Abe, R., & Rabinovitch, P. S. (1997). Measurement of Intracellular Calcium Ions by Flow Cytometry. *Current Protocols in Cytometry*, 2(1), 9.8.1-9.8.19. <https://doi.org/10.1002/0471142956.cy0908s02>
31. Pbs, D., Cell, D., Medium, L., I-, M. P., Procedure, E., & Vortex, D. O. N. O. T.
 (n.d.). *Alcium lux rotocol*. 7–8.
32. *calcium-indicators* @ *www.thermofisher.com*. (n.d.).
https://www.thermofisher.com/de/de/home/life-science/cell-analysis/cell-viability-and-regulation/ion-indicators/calcium-indicators.html?gclid=EAlalQobChMI8q3joomj4gIVRR-GCh0TYwnLEAAYASAAEgJBv_D_BwE&ef_id=EAlalQobChMI8q3joomj4gIVRR-GCh0TYwnLEAAYASAAEgJBv_D_BwE:G:s&s_kwid=AL!3652!3!328654650894!p!!g!!calciumindicator&ef_id=CjwKCAjw4KD0BRBUEiwa7MFNTfsJBImnwdalNWLF4KwpsOBog

s0yyQtflvCqyXSH8JtOidKOL_c3XR0CBXwQAvD_BwE:G:s&s_kwcid=AL!3652!3!378
136343491!b!!g!!%2Bfluo-
4?cid=bid_pca_iva_r01_co_cp1359_pjt0000_bid00000_0se_gaw_nt_pur_con

33. <https://biotium.com/product/fluo-4-ester/>
34. <https://www.moleculardevices.com/applications/live-cell-imaging>
35. <https://www.ncbi.nlm.nih.gov/pmc/articles/PMC4198327/>
36. [https://www.labome.com/method/Fetal-Bovine-Serum.html#:~:text=Fetal%20bovine%20serum%20\(FBS\)%20is,the%20major%20component%20of%20FBS.](https://www.labome.com/method/Fetal-Bovine-Serum.html#:~:text=Fetal%20bovine%20serum%20(FBS)%20is,the%20major%20component%20of%20FBS.)
37. [https://www.elabscience.com/p-pbs_buffer_ph7.4_\(10_%C3%97\)-126132.html?gclid=CjwKCAjwkoz7BRBPEiwAeKw3qxI0F6Q52mAM7EkW-6tgnOM9IzI1WYSjs9cr8r6Q_hGxuKXVivOH1xoCRBUQAvD_BwE](https://www.elabscience.com/p-pbs_buffer_ph7.4_(10_%C3%97)-126132.html?gclid=CjwKCAjwkoz7BRBPEiwAeKw3qxI0F6Q52mAM7EkW-6tgnOM9IzI1WYSjs9cr8r6Q_hGxuKXVivOH1xoCRBUQAvD_BwE)
38. Life, S. (2019). *Tip* :
https://ibidi.com/img/cms/products/labware/open_standard/S_8082X_8Well/I_N_8082X_8well.pdf
39. <https://biotium.com/product/fluo-4-ester/#:~:text=Fluo%2D4%20AM%20ester%20is,that%20gives%20higher%20fluorescence%20signal.>

40. *45-8-well-chamber-removable @ ibidi.com*. (n.d.). <https://ibidi.com/chamber-slides/45-8-well-chamber-removable.html>

41. <https://www.ncbi.nlm.nih.gov/pmc/articles/PMC2666335/>